

SMRT1

Single Phase Relay Test System



- **Small, rugged, lightweight and powerful**
- **Operate with or without a computer**
- **Intuitive manual operation with Smart Touch View Interface**
- **High current, high power (60 Amps/300 VA rms)**
- **Network interface provides IEC 61850 test capabilities**
- **Fully automated testing using AVTS software**

DESCRIPTION

As a stand-alone unit the SMRT1 has the “smart” combination of high compliance voltage and high current to test electromechanical, solid-state and microprocessor-based overcurrent relays, including voltage controlled, voltage restraint and directional overcurrent; test under/over voltage, single-phase impedance, single-phase power, directional, synchronizing, auto-synchronizing, negative sequence under/over voltage, current balance, frequency, volts/hertz, reclosing, thermal, and various other relays, see the Applications Guide for more.

The SMRT1 test system has the ability to be manually controlled with Megger’s new Smart Touch View Interface™ (STVI). The STVI, with its large, full color, high resolution, TFT LCD touch screen allows the user to perform manual, steady-state and dynamic testing quickly and easily using the manual test screen, as well as using built-in preset test routines for most popular relays.

The STVI eliminates the need for a computer when testing virtually all types of relays. Menu screens and touch screen



Model STVI with SMRT1

function buttons are provided to quickly and easily select the desired test function. Tests results can be saved to the PowerDB™ ONBOARD for download to a memory stick to transfer or print test reports. For full automatic testing the SMRT1 may be controlled by Megger Advanced Visual Test Software (AVTS). AVTS is a Microsoft® Windows® XP®/ Vista™/7 compatible software program designed to manage all aspects of protective relay testing using the new Megger SMRT.

APPLICATIONS

The current channel is rated for 30 Amps @ 200 VA continuous, up to 60 Amps @ 300 VA for short durations. It has a unique flat power curve from 4 to 30 Amps that insures maximum compliance voltage to load at all times. With a high compliance voltage of 50 Volts the SMRT1 has the capability to test high impedance overcurrent relays.

The voltage channel can provide a variable output of 0- 30/150/ 300 Volts at 150 VA of output power, and has a unique flat power curve from 30 to 150 Volts insuring maximum output power to the load at all times. With the voltage channel converted to current, it can perform minimum operating point, slope, and timing on current differential relays, including harmonic restraint transformer differential relays (which can be tested one phase at a time).

It is also designed to operate in conjunction with other SMRT family units. Using the Ethernet ports, SMRT1 is literally a “plug-and-play” unit, where voltage and current outputs can be seamlessly synchronized with other SMRT units voltage and current outputs for testing more complex relays like three phase directional power, distance, loss of excitation, or 6, 9 up to 12 phase current test applications.

APPLICATIONS SELECTION GUIDE

Protective Relays by IEEE Device #		SMRT1
2	Time Delay	✓
21	Distance Single Phase	✓
21	Distance Open Delta	+
21	Distance Three Phase wye	++
24	Volts/Hz	✓
25	Synchronizing	+
27/59	Under/Over Voltage	✓
32	Directional Power Single Phase	✓
32	Directional Power Three Phase (Open Delta)	+
37/76	DC Under/Over Voltage/Current	✓
40	Loss of Field	✓
46	Phase Balance Current	✓
46N	Negative Sequence Overcurrent	✓
47	Phase Sequence Voltage (Open Delta)	+
50	Instantaneous Overcurrent	Up to 75 Amps
51	Time Overcurrent	Up to 75 Amps
55	Power Factor	✓
60	Voltage/Current Balance (Open Delta)	+
67	Directional Overcurrent	✓
67N	Ground Directional Overcurrent	✓
78	Out of Step	✓
79	Reclosing	✓
81	Frequency	✓
85	Carrier or Pilot Wire	✓
87	Differential	✓
91	Voltage Directional (Open Delta)	+
92	Voltage and Power Directional (Open Delta)	+
94	Tripping	✓

+ Requires additional SMRT1 for each +

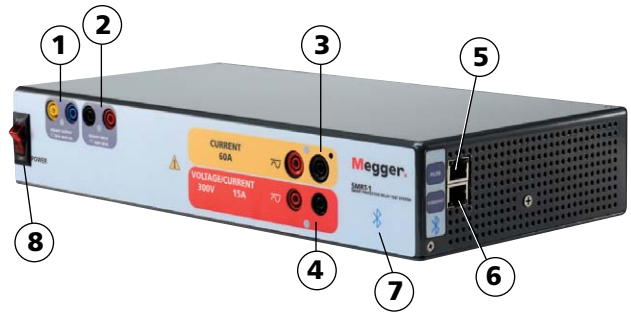

- 1. Binary Output:** Rated for 300 V at 8 Amps.
- 2. Binary Input:** Rated 5 to 300 V AC/DC
- 3. Current Channel:** 0 – 30 Amps at 200 VA continuously, up to 60 Amps at 300 VA for short durations.
- 4. Voltage Channel:** 0 - 300 V at 150 VA, convertible to current rated for 5 Amps at 150 VA continuously, 15 A at 120 VA for short durations.
- 5. PC/IN:** Ethernet Port is the primary PC connection port. This port may also be used for connecting to other SMRT units.
- 6. 61850/OUT:** Ethernet Port may be used to interconnect multiple SMRT units together for synchronous multi-unit operation, or for connecting to the IEC 61850 substation bus.
- 7. Blue Tooth:** Bluetooth® provides wireless control.
- 8. POWER ON/OFF:** Switch illuminates when power is on.

FEATURES AND BENEFITS

Constant Power Output – New higher powered Voltage-Current amplifiers. The current amplifier delivers maximum compliance voltage to the load constantly during the test, and range changing is done automatically under load. This insures better test results, and saves time by not having to turn the outputs off to change ranges. Constant power output in many cases eliminates the need to parallel or series current channels together to test high burden relays.

High Output Current – Provides up 30 Amps at 200 VA per phase continuous for timing tests, and can provide up to 60 Amperes at 300 VA for testing instantaneous overcurrent relays.

New PowerV™ Voltage Amplifier High Power Output – The SMRT provides a new higher VA power output on the voltage channel at the lower critical test voltages (from 30 to 150 Volts). Customers who want to test a panel of relays at one time find it impossible using lower VA rated voltage sources.

High resolution and accuracy – Metered outputs provides extremely high accuracy needed for testing a wide variety of devices. Eliminates uncertainty with setting values, with metered values what you see is what you get.

Steady-State and Dynamic testing capability – The SMRT1 provides, either through manual control or computer control, both steady-state and dynamic testing of protective relays. This includes programmable waveforms with harmonics.

Output current and voltage sine waves are generated digitally – Outputs do not vary with sudden changes in input voltage or frequency, which increases test accuracy and reduces testing time.

Digital binary input and output – The programmable binary input, and programmable output provide timing and logic operations in real-time with the output voltage and currents. The Binary Input can be programmed, using Boolean logic, for more complex power system simulations.

Circuit breaker simulator – Binary output provide programmable normally closed or normally open contacts to simulate circuit breaker operation for testing reclosing relays. Sequence of operation, timing, and lockout are easily tested.

Performs transient tests – Perform acceptance or troubleshooting tests by replaying digitally recorded faults or EMTP/ATP simulations in the IEEE- C37.111, COMTRADE Standard format.

Perform End-to-End tests – Using AVTS software and a GPS satellite receiver, the SMRT performs satellite-synchronized end-to-end dynamic multi-state or playback transient COMTRADE files either for commissioning or troubleshooting tests.

Wide-ranging output frequency – The output frequency of the current and voltage outputs can be set for any frequency from dc to 1 kHz. Popular test frequencies such as 16.66, 25, 33, 50, 60, 100,120, 125, 150, 180, 250, 300 and 400 Hz are easily set and controlled. Multi-purpose test system saves time and money.

Two Ethernet ports – PC/IN Ethernet Port is the primary PC connection port. It is also used when chaining multiple SMRT units together. The 61850/OUT Ethernet Port is primarily used to interconnect multiple SMRT units together for synchronous multi-unit operation, or it may be used to connect to the IEC 61850 substation bus.

Universal input voltage – Operation from 90 to 264 VAC, 50/60 Hz, the SMRT can use virtually any standard source in the world.

Immediate error indication – Audible and visual alarms indicate when amplitude or waveforms of the outputs are in error.

BlueTooth – Optional Bluetooth provides more flexibility. A wireless interface between the PC and SMRT, in conjunction with the SMRT IEC 61850 Ethernet port, provides the isolation required for a secure substation access interface between the SMRT and the IEC 61850 substation network.

SPECIFICATIONS¹

Input Power

100 to 240 Volts (± 10%) AC, 1Ø, 50/60 Hz, 700 VA

Outputs

All outputs are independent from sudden changes in line voltage and frequency. This provides stable outputs not affected by sudden changes in the mains source. All outputs are regulated so changes in load impedance do not affect the output.

Output Current

Output power ratings are specified in AC rms values and peak power ratings.

Output Current	Power	Max V / Duty Cycle
1 Ampere	15 VA	15.0 V rms Continuous
4 Amperes	200 VA (282 peak)	50.0 V rms Continuous
15 Amperes	200 VA (282 peak)	13.4 V rms Continuous
30 Amperes	200 VA (282 peak)	6.67 V rms Continuous
60 Amperes	300 VA (424 peak)	5.00 V rms 90 Cycles
DC 200 Watts		

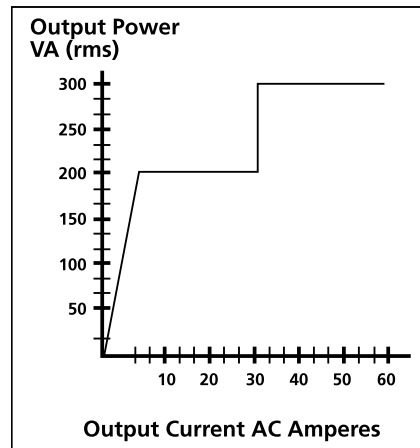

Current Amplifier Output Power Curve

Current Amplifier - Extended Power Range

The SMRT current amplifier provides a unique flat power curve from 4 to 30 Amperes to permit testing of electromechanical high impedance relays, and other high burden applications, with an extended operating range up to 60 Amperes at 300 VA rms.

AC Voltage Output

Outputs are rated with the following Ranges:

Output Volts	Power	Max I
30 Volts	150 VA	5 Amps
150 Volts	150 VA	See "PowerV"
300 Volts	150 VA	0.5 Amps
DC 150 Watts		

Duty Cycle: Continuous

¹ Megger reserves the right to change product specifications at any time.

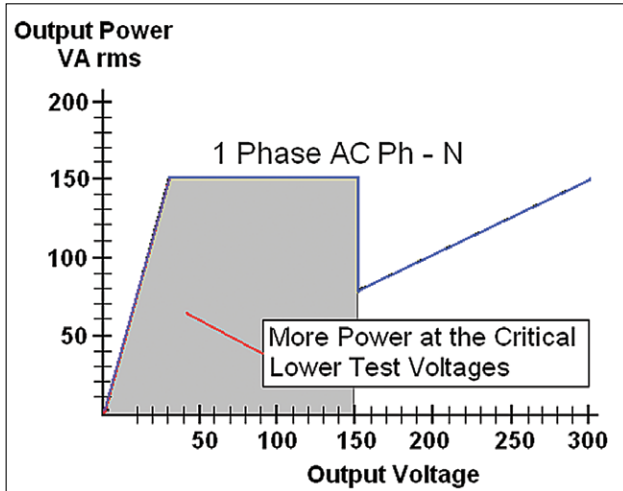

“PowerV” Voltage Amplifier - Extended Power Range

The SMRT voltage amplifier provides a flat power curve from 30 to 150 Volts in the 150V range to permit testing of high current applications such as panel testing.

Voltage Amplifier in Current Mode:

The voltage amplifier is convertible to a second current source with the following output capability. Output power ratings are specified in rms values and peak power ratings.

Output Current	Power	Max V Duty Cycle
5 Amperes	150 VA (212 peak)	30.0 Vrms Continuous
15 Amperes	120 VA	8.0 Vrms 90 Cycles

Phase Angle

Ranges: 0.00 to 359.99 degrees, Counter Clock Wise, or Clock Wise rotation, or 0.00 to ±180.00 degrees

Accuracy: ±0.02° typical, ±0.25° max at 50/60 Hz

Frequency

The output modules provide a variable frequency output with the following ranges and accuracy.

Ranges

DC

0.001 to 1000.000 Hz

Output amplifiers can provide transient signals with a range of DC to 10 kHz for transient playback using COMTRADE files.

Resolution*: .0001/.001 Hz

Frequency Accuracy:

2.5 ppm typical

25 ppm 0° to 50° C, at 50/60 Hz Maximum

Total Harmonic Distortion

Less than 0.1% typical, 2% maximum at 50/60 Hz

Timer

The Timer-Monitor Input is designed to monitor and time-tag inputs, as a sequence of events recorder. In addition, the binary input controls enable the user to perform logic AND/OR functions, and conditionally control the binary output relay to simulate circuit breaker, trip, reclose and carrier control operation in real-time. The Timer function displays in Seconds or Cycles, with the following range and resolution:

Seconds: 0.0001 to 99999.9 (Auto Ranging)

Cycles: 0.01 to 99999.9 (Auto Ranging)

Accuracy: ±0.001% of reading, typical. ±2 least significant digit, ±0.005% of reading from 0 to 50° C maximum

Binary Input – Start/Stop/Monitor Gate

To monitor operation of relay contacts or trip SCR, continuity light is provided for the input gate. Upon sensing continuity the lamp will glow. In addition to serving as wet/dry contacts the Binary Inputs may be programmed to trigger binary output sequence(s). Input Rating: up to 300 V AC/DC

Binary Output Relay

SMRT1 has an independent, galvanically isolated, output relay contact to accurately simulate relay or power system inputs to completely test relays removed from the power system. The binary output simulates normally open / normally closed contacts for testing breaker failure schemes. The binary output can be configured to change state based on binary input logic.

AC Rating: 400 V max., **I_{max}:** 8 amps,

2000 VA max. breaking capacity

DC Rating: 300 V max., **I_{max}:** 8 amps, 80 W

Response Time: < 10ms

Waveform Generation

Each output channel can generate a variety of output waveforms such as: DC; sine wave; sine wave with percent harmonics at various phase angles; half waves; square waves with variable duty cycles; exponential decays; periodic transient waveforms from digital fault recorders, relays with waveform recording capability or EMT/ATP programs, which conform to the IEEE C37.111 COMTRADE standard format.

Metering

Measured output quantities such as AC Amperes, AC Volts, DC Volts or DC Amperes, and Time may be simultaneously displayed on the large, color TFT LCD, optional STVI touch screen. The AC and DC outputs display the approximate voltage/current output prior to initiation of the outputs.

AC Voltage Amplitude

Accuracy: ±0.05% reading + 0.02% range typical, ±0.15% reading + 0.05% range maximum

Resolution: .01

Measurements: AC RMS

Ranges: 30, 150, 300V

AC Current Amplitude

Accuracy: ±0.05% reading + 0.02% range typical, ±0.15% reading + 0.05% range maximum

Resolution: .001/.01

Measurements: AC RMS

Ranges: 30, 60A

DC Voltage Amplitude

Accuracy: 0.1% range typical, 0.25% range maximum

Resolution: .01

Measurements: RMS

Ranges: 30, 150, 300V

DC Current Amplitude

Accuracy: ±0.05 % reading + 0.02 % range typical, ±0.15 % reading + 0.05 % range maximum

Resolution: .001/.01

Measurements: RMS

Ranges: 30A

Convertible Source in AC Current Mode

Accuracy: ±0.05% reading + 0.02% range typical, ±0.15% reading + 0.05% range or ±12.5 mA whichever is greater

Resolution: .001

Measurements: AC RMS

Range: 5, 15A

Temperature Range**Operating:** 32 to 122° F (0 to 50° C)**Storage:** -13 to 158° F (-25 to 70° C)**Relative Humidity:** 5 - 90% RH, Non-condensing**Unit Enclosure**

The SMRT1 unit comes housed in a rugged, metal, lightweight enclosure. IEC Enclosure Rating IP20

Dimensions

13.5W x 2.4H x 6.75D in. (33.75W x 6H x 16.88D cm)

Weight

8.9 lb. (4 kg)

Conformance Standards**Safety:** EN 61010-1**Shock:** MIL-PRF-28800F (30g/11ms half-sine)**Vibration:** MIL-RFP-28800F (5-500Hz, 2.05 g rms)**Transit Drop:** MIL-RFP-28800F

(10 drops, 20 cm, without transit case)

EMC Emissions: EN 61326-2-1, EN 61000-3-2/3,

FCC Subpart B of Part15 Class A

Immunity: EN 61000-4-2/3/4/5/6/8/11**Protection**

Voltage outputs are protected from short circuits and thermally protected against prolonged overloads. Current outputs are protected against open circuits and thermally protected against prolonged overloads.

Communication Interfaces

Ethernet (2)

Bluetooth (optional)

SOFTWARE**AVTS – STVI Basic**

Every unit comes with **AVTS Basic** software and the PC version of the **STVI Basic** software packages. AVTS Basic version includes Online Vector control (for single and multi-state timing tests), Online Ramp control (for automatic ramping of voltage, current, phase angles or frequency) and Online Click-On-Fault (for dynamic tests of impedance relays). Test results may be exported directly to Microsoft Word. AVTS software includes a database for saving test results, which can also provide the necessary information needed for system reliability audits. See **AVTS** bulletin for more information.

The PC version of the STVI software includes the ability to bring all STVI test data (from other STVI units) into file folders for retrieval, review and printing whenever needed. See **STVI** bulletin for more information.

AVTS Advanced

The **AVTS Advanced** version includes all the features in AVTS Basic plus the powerful Test Editor, Dynamic Control (includes dynamic end-to-end testing capability, and waveform recording capability), Modbus communication test capability, ASPEN OneLiner™ or Electrocon CAPE™ SS1 File Converter for dynamic testing, and easy to use programming Tools for creating and editing test modules. See **AVTS** bulletin for more information.

AVTS Professional

The **AVTS Professional** version includes all of the features of the Basic and Advanced versions plus some other powerful test tools and features. It includes the DFR Waveform Viewer, One-Touch™ Test for fully automatic tests, and Waveform Digitizer to digitize scanned waveforms of electromechanical over current time curves. See **AVTS** bulletin for more information.

IEC 61850 GOOSE

The SMRT with the GOOSE enabled, in conjunction with the Megger GOOSE Configurator (MGC) software, can be used in the testing or commissioning of IEC 61850 compliant devices. See **AVTS** bulletin for more information.

ORDERING INFORMATION

STYLE NUMBER IDENTIFICATION

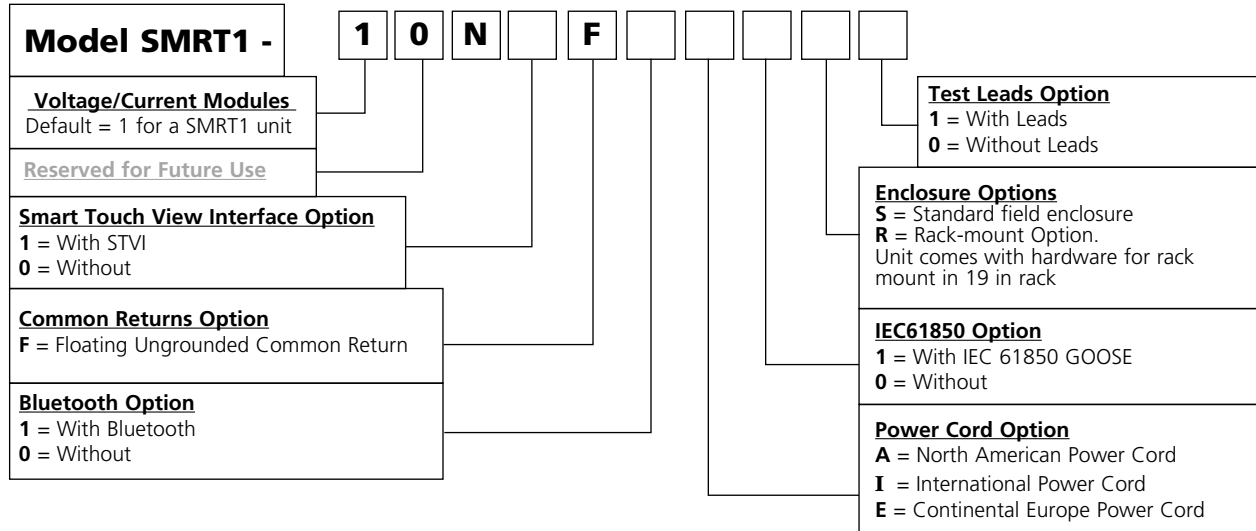

DESCRIPTION OF SOFTWARE OPTIONS

Included Software	Part Number
AVTS Basic with STVI Application CD	81302
AVTS Basic with IEC 61850 Megger GOOSE Configurator, and STVI Application CD	1002-103
Software Options	
AVTS Advanced with STVI Application CD	81570
AVTS Advanced Test with IEC 61850 Megger GOOSE Configurator, and STVI Application CD	1001-106
AVTS Professional with STVI Application CD	81571
AVTS Professional Test with IEC 61850 Megger GOOSE Configurator, and STVI Application CD	1002-102

DESCRIPTIONS OF HARDWARE OPTIONS

Voltage/Current Module: The SMRT1 by default the first digit will always be **1**.
Future: 0, Reserved for future use.
Base Unit Options: SMRT1 does not have any Base Unit options. By default this digit is **N** for None.
Smart Touch View Interface Option: Enter the number **1** for the unit to come with the STVI, or enter the number **0** for without.
Common Returns Option: The SMRT1 unit has only one option, at this time, for the return terminals associated with each output channel. It is **F** for floating returns.
Bluetooth Option: For customers who wish to have a wireless control of the SMRT unit, enter the number **1** for the unit to come with the Bluetooth option installed. Enter **0** for without.
Power Cord Option: Customers can choose which type of power cord they want the unit to come with.

- A Option** – NEMA 5-15 to IEC60310 C13 connectors, UL & CSA approved for countries with NEMA outlets.

- I Option** - International color coded wires (light blue, brown and green with yellow stripe) insulation jacket stripped ready for male connector with IEC 60320 C13 connector. CE marked.
 - E Option** - CEE 7/7 “Schuko” plug to IEC 60320 C13 connector is CE marked.
- IEC 61850 Option:** The SMRT1 in conjunction with the Megger GOOSE Configurator (MGC) software can be used in the testing or commissioning of IEC 61850 compliant devices. In order for the SMRT1 to be able to subscribe as well as publish GOOSE messages, the IEC 61850 feature needs to be enabled. Enter the number **1** for the unit to come with the IEC 61850 option enabled. Enter **0** for the unit without IEC 61850 enabled.
- Enclosure Option:** The options are **S** for Standard, and **R** for rack mount. Enter **S**, for Standard, rugged metal field type enclosure. The rack unit will come in a metal enclosure with 19 inch rack mount hardware installed.
- Test Leads Option:** Enter the number **1** for the unit to come with Test Leads. Enter **0** for the unit without Test Leads.

DESCRIPTION

Included Standard Accessories	Part Number
Power Cord - Depending on the style number, the unit will come with one of the following,	
Line cord, North American	620000
Line cord, Continental Europe with CEE 7/7 Schuko Plug	50425
Line cord, International color coded wire	15065
Ethernet crossover cable for interconnection to PC, 210cm (7 ft.) long (Qty. 1 ea)	620094
Instruction manual CD	80989

Table of Accessories

Accessories are supplied with the selection of the Test Leads Option and/or the STVI Option. If desired, Test Leads and Accessories can be ordered individually, see description and part numbers below.

	Optional Accessories Descriptions	STVI and/or Test Leads Option	Test Leads Option
	Accessory Carry Case: Use to carry power cord, Ethernet cable, Optional STVI and test leads.	Qty. 1 ea. Part No. 2001-487	
	Sleeved Pair of Test Leads: Keeps the test leads in pairs and from getting entangled. Sleeved Test Leads, one red, one black, 200 cm (78.7") long, 600 V, 32 Amperes CAT II		Qty. 4 pr. Part No. 2001-394
	Cable/Spade Lug Adapter (Small): Small lug fit most new relay small terminal blocks. Lug adapter, red, 4.1 mm, use with test leads up to 1000 V/ 20 Amps CAT II		Qty. 4 ea. Part No. 684004
	Lug adapter, black, 4.1 mm, use with test leads up to 1000 V/ 20 Amps CAT II		Qty. 4 ea. Part Number 684005
	Jumper Lead: Used to common returns together on units with floating ground returns, or parallel of current channels. Jumper lead, black, 12.5 cm (5") long, use with voltage / current outputs, 600 V, 32 Amps CAT II		Qty. 1 ea. Part Number 2001-573

Descriptions of Software

Included Software – Every unit comes with AVTS Basic and the PC version of the STVI Basic Test software packages

AVTS Basic with STVI Application Software (PC Version) Part No.: 81302

AVTS Basic includes Online Vector, Online Ramp and Online Click-On-Fault controls, with the ability to import, save and execute relay specific test modules. The online tools of Vector and Ramp provide automatic pickup, or dropout tests as well as timing and multi-state dynamic tests. The Online Click-On-Fault tool is used to automatically determine the reach characteristics of single or multi-zone Distance relays using shot for single point tests, or Ramp, Pulse Ramp, or Binary Search tools along user defined search lines. Includes enhanced Relay Test Wizards for; Overcurrent, Differential, Voltage, Frequency and Distance relays.

The powerful STVI screens can be run directly from a PC providing both manual and automatic test capabilities. Intuitive menu screens and buttons are provided to quickly and easily select the desired test function. The Manual Test Screen power-up preset default values maybe automatically set from the user defined configuration screen. The user can select from a variety of test options including manual control using the cursor up down arrows or use the mouse

control wheel to vary outputs. In addition a dynamic sequence test includes trip and reclose up to 9 operations. An automatic ramp, pulse ramp, binary search or pulse ramp binary search is built in to determine pickup or drop out of relay contacts, or perform relay specific timing tests using the Timing Test Screen. A vector graph indicates the relative phase angles of all of the outputs. The user may select to have all output amplitudes metered to provide real time verification of all of the selected outputs, or have setting values displayed. The PC version of the STVI software includes the ability to bring all STVI test data (from other STVI units) into file folders for retrieval and review whenever needed. Each copy of the PC version of the STVI software is licensed for running on one PC. Additional run keys can be purchased separately.

Additional Software Options

AVTS Advanced with STVI Application Part No.: 81570

AVTS Advanced includes all of the features of AVTS Basic in addition to the powerful Test Editor and test editor tools, which includes the Dynamic Control (with dynamic end-to-end test capability, and Recorder features) for developing sequential tests for virtually any function or measuring element within digital relays. In addition, it also includes Modbus communications for automatic download of settings, SS1 File Converter for ASPEN and CAPE dynamic test files, End-to-End DFR Playback test macros and basic programming Tools for creating and editing test modules. Test files created in Advanced Test can be used with AVTS Basic.

AVTS Professional with STVI Application Part No.: 81571

Professional Test includes all of the features of AVTS Advanced Test version plus the following additional specialized test tools. The DFR Waveform Viewer and Playback tools are used for viewing and analyzing IEEE C37.111 COMTRADE Standard files from digital fault recorders and microprocessor based relays. The DFR Waveform Viewer includes tools to recreate the analog and digital channels for playback into protective relays for troubleshooting or evaluation. It includes the capability to extend the prefault data as well as start the timer associated with the event to time relay operation. These playback test files can also be used in end-to-end tests to recreate the transient event and evaluate the protection scheme. Test files created in Professional can be used with Advanced Test and Basic. Also included is the One-Touch Test Editor Control Tool for fully automatic testing of microprocessor based relays using VB script files to automatically download relay settings, and automatically test all the measuring elements within the relay based upon those settings. The Waveform Digitizer feature is also included in the Professional Test version of AVTS. It provides tools to create digital time curves for virtually any electromechanical relay time curve (that do not fit a time curve algorithm). It can even be used for digitizing scanned waveforms from a light-beam chart recorder.

IEC 61850 Megger GOOSE Configurator Software

The Megger GOOSE Configurator (MGC) provides easy to use tools for testing relays and substations using the IEC 61850 protocol. It is an optional software tool available with Basic, Advanced or Professional versions of AVTS Software; see Descriptions of Software Options above. The configurator provides relay test engineers and technicians the capability to import parameters from configuration files in the Substation Configuration Language (SCL) format, and/or capture GOOSE messages directly from the substation bus. All imported GOOSE messages will be unconfirmed messages. Only captured messages are confirmed messages due to the Capture feature of the MGC. Use the MGC Merge feature to compare imported SCL and captured GOOSE messages to verify all GOOSE messages needed to perform tests. Use them to configure the SMRT to subscribe to preselected GOOSE messages by assigning the data attributes to the appropriate binary inputs of the SMRT. Use the configurator to assign the appropriate binary

outputs of the SMRT to publish GOOSE messages simulating circuit breaker status. After the appropriate assignments of binary inputs and outputs have been made, the test file can be saved for reuse. This provides both manual and automatic testing of the relay using either the STVI or AVTS software. Use standard test modules in AVTS to perform automatic tests. Use the Dynamic Control in AVTS Advanced or Professional to perform high speed trip and reclose tests, or use to perform interoperability high-speed shared I/O tests between multiple IED's. The MGC provides mappings of Boolean and Bit Strings and/or simulation of STRuct, Integer/Unsigned, Float and UTC datasets.

**Additional Accessories
(Not Included in the SMRT1 Test Leads Option)**

Additional Optional Test Leads and Accessories can be ordered individually, see description and part numbers below. The following accessories and part numbers are in quantities of 1 each. Order the appropriate number required.

Description	Part No.
Individual (Non-Sleeved) Test Leads: Excellent for widely separated individual terminal test connections.	
	
Test Lead, red, use with voltage/current output, or binary I/O, 200 cm long (78.7") 600 V/32 Amps CAT II.	620143
Test Lead, black, use with voltage/current output, or binary I/O, 200 cm long (78.7") 600 V/32 Amps CAT II.	620144

Cable / Spade Lug Adapter (Large): Large spade lug fits older relay terminal blocks, or STATES® Company FTP10 or FTP14 Test paddles, ABB or General Electric test plugs with screw down terminals.	
	
Lug adapter, red, 6.2 mm, use with test leads up to 1000 V/20 Amps CAT II.	684002
Lug adapter, black, 6.2 mm, use with test leads up to 1000 V/20 Amps CAT II.	684003

Alligator/Crocodile Clip: Excellent for test connections to terminal screws and pins where spade lugs cannot be used.	
	
Alligator clip, red, use with test leads up to 1000 V/32 Amps CAT III.	684006
Alligator clip, black, use with test leads up to 1000 V/32 Amps CAT III.	684007

Flexible Test Lead Adapter: Use with rail-mounted terminals or screw clamp connections where spade lugs and crocodile/alligator clips cannot be used.	
	
Flexible test lead adapter, black, 1.8 mm male pin, use with test leads up to 1000 V/32 Amps CAT III.	90001-845

Description	Part No.
Flexible Test Lead Adapter with Retractable Insulated Sleeve: Use for connection to old style non-safety sockets with retractable protective sleeve on one end.	
	
Retractable Sleeve Test Lead, red, 50 cm (20") long, use with test leads up to 600 V, 32 Amperes CAT II.	90001-843
Retractable Sleeve Test Lead, black, 50 cm (20") long, use with test leads up to 600 V, 32 Amperes CAT II.	90001-844

In-Line Fused Test Lead: Use with high speed binary outputs 5 or 6 ("P" Option) to protect for accidental switching of currents higher than 1 Amp.	
	
Test lead, blue, in-line 500 mA fuse protection, 200 cm long (78.7").	568026

In-Line Fused Test Lead: Use with ("P" Option) Battery Simulator output to protect for accidental connection to substation battery.	
	
Test lead, black, in-line 3.15 A fuse protection, 200 cm long (78.7").	568025

In-Line Resistor Test Lead: Use with old solid state relays with "leaky" SCR trip gates.	
	
Test lead, red, in-line 100 k Ohm resistor, use with test leads up to 1000 V/ 32 Amps CAT III.	500395

STATES® Company 10 Pole Test Paddle: Use with STATES FMS Test Switch or ABB FT-1 10 pole Test Switch.	
	
Test paddle features knobs which also serve as insulated Ø 4 mm rigid socket accepting spring loaded Ø 4 mm plugs with rigged insulating sleeve, or retractable sleeve. Use with test leads up to 600 V, 32 Amperes CATII.	FTP10

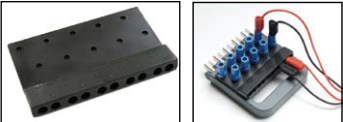
STATES® Company 10 Pole Test Paddle Attachment: Use with STATES Company FTP10 Test Paddle.	
	
Test paddle attachment provides an additional 10 insulated connection points for front connection, as well as the standard top connections for test leads. Adapter can provide convenient parallel test connections of test currents to two terminals at one time. Use with test leads up to 600 V, 32 Amperes CAT II.	TPA10

UK

Archcliffe Road Dover
CT17 9EN England
T +44 (0) 1304 502101
F +44 (0) 1304 207342

UNITED STATES

4271 Bronze Way
Dallas TX 75237-1088 USA
T 800 723 2861 (USA only)
T +1 214 333 3201
F +1 214 331 7399

OTHER TECHNICAL SALES OFFICES

Norristown USA, Sydney AUSTRALIA,
Toronto CANADA, Trappes FRANCE,
Kingdom of BAHRAIN, Mumbai INDIA,
Johannesburg SOUTH AFRICA and
Conjure THAILAND.

ISO STATEMENT

Registered to ISO 9001:1994 Reg no. Q 09250

Registered to ISO 14001 Reg no. EMS 61597

SMRT1_DS_en_V02

www.megger.com

Megger is a registered trademark